

# CAT

by HERMAN VAN GOUBERGEN

USE HALF A SQUARE OF WHITE PAPER (PHOTOCOPY PAPER WORKS WELL)

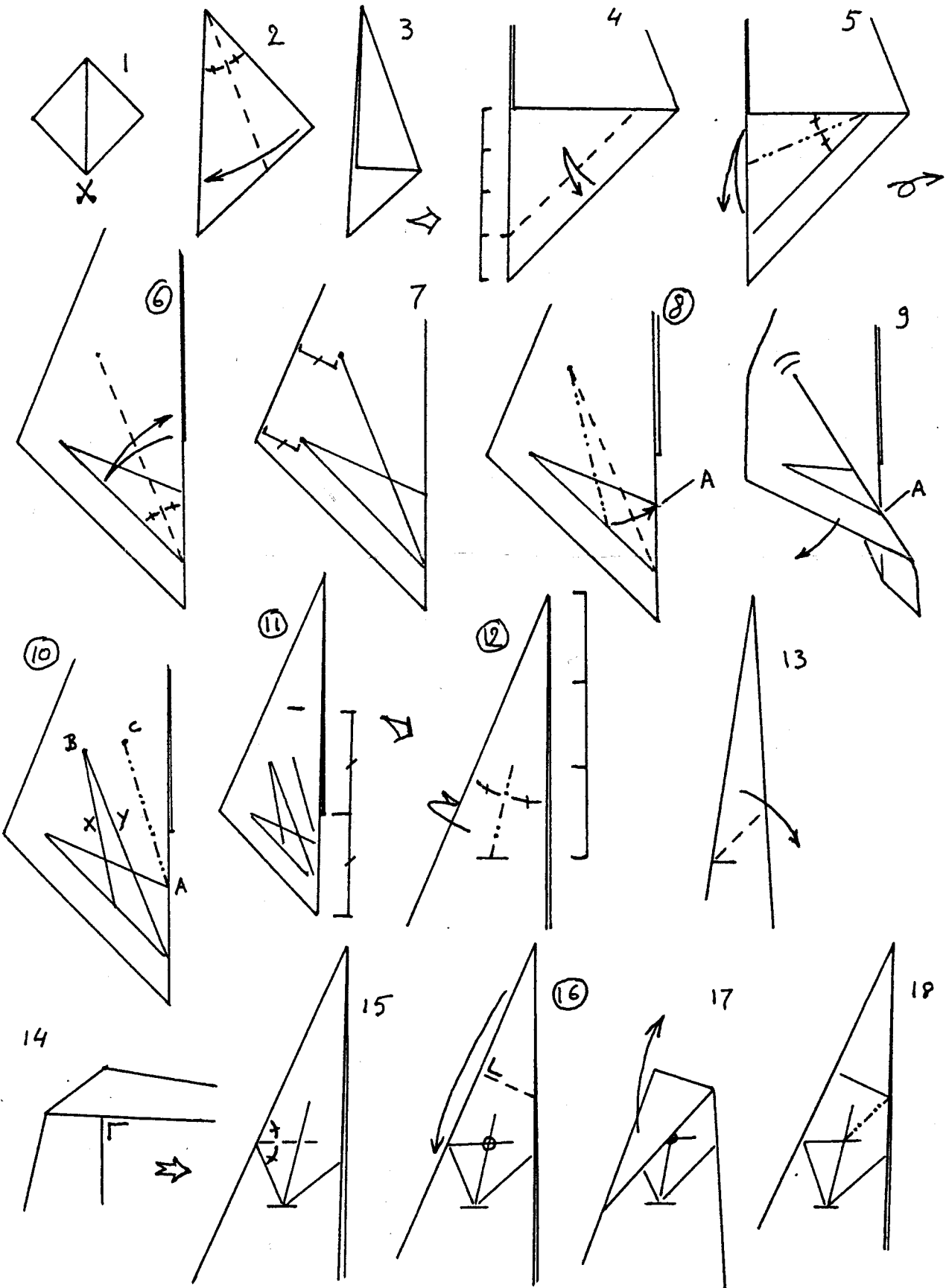

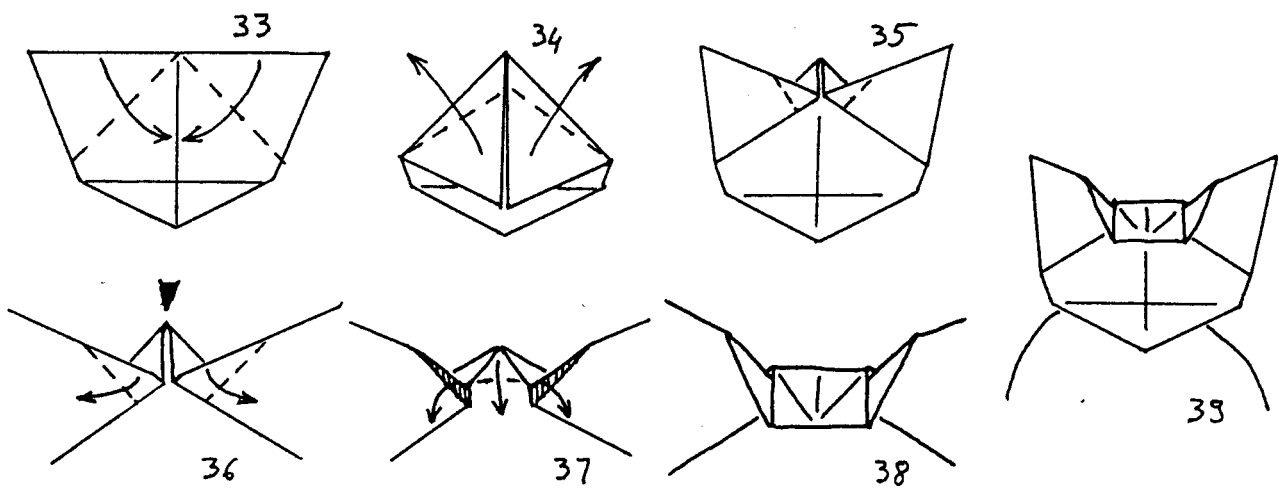
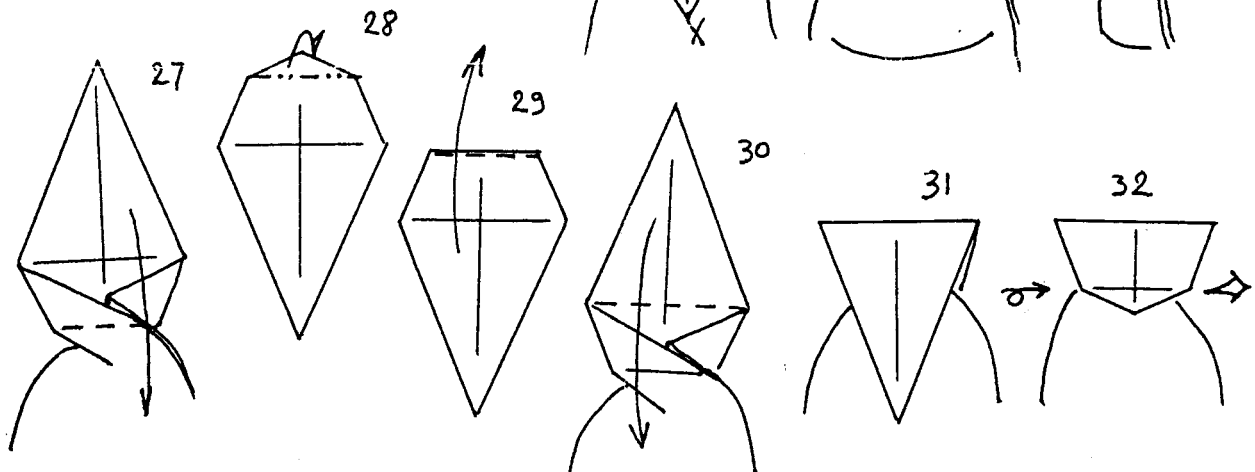
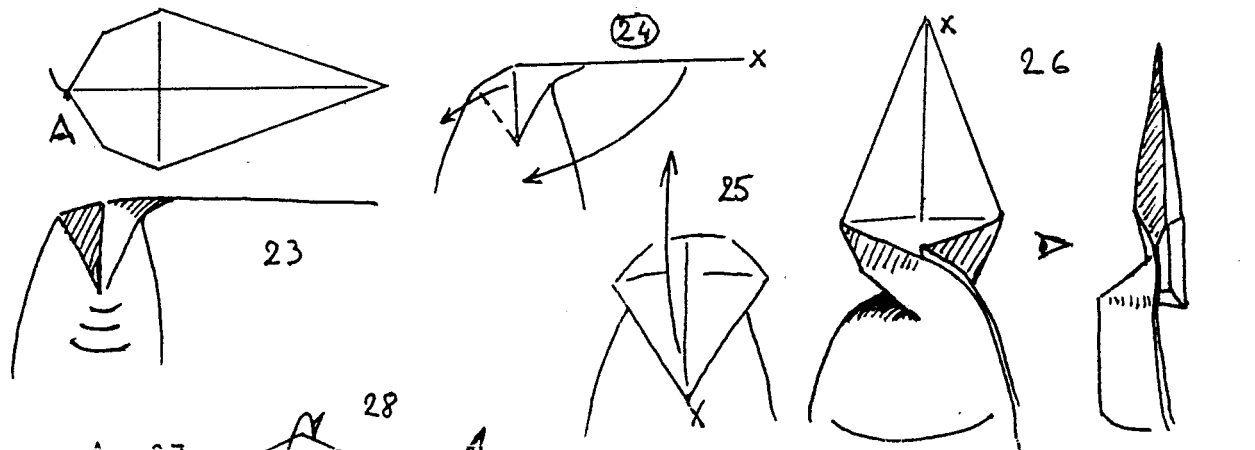
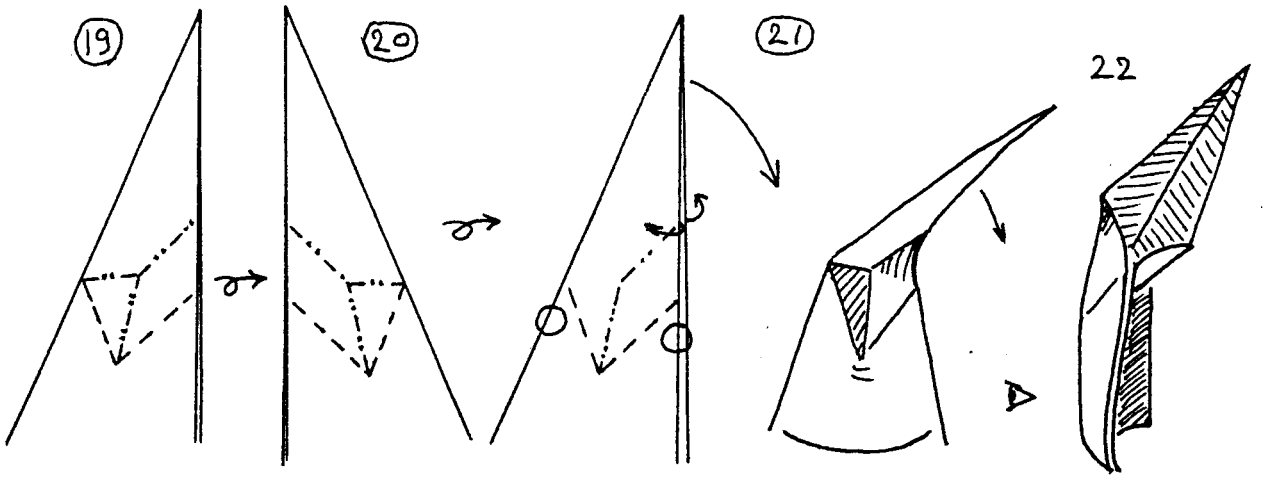

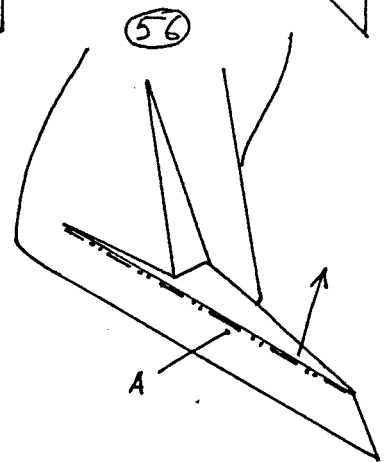
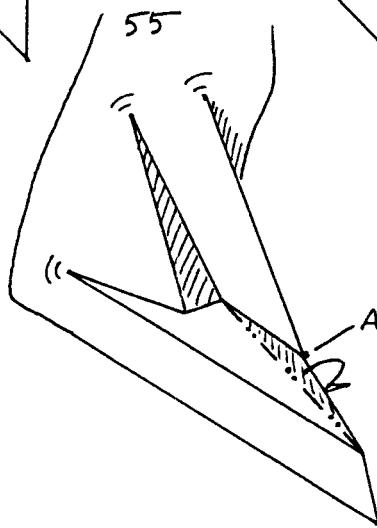
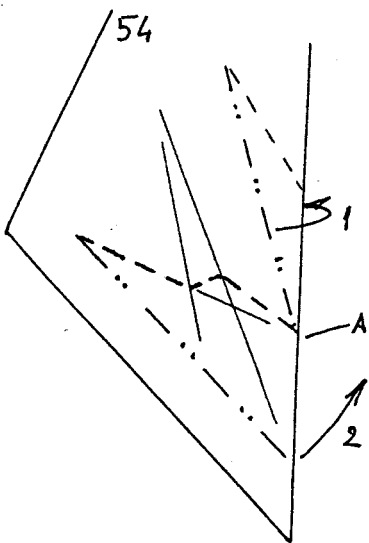
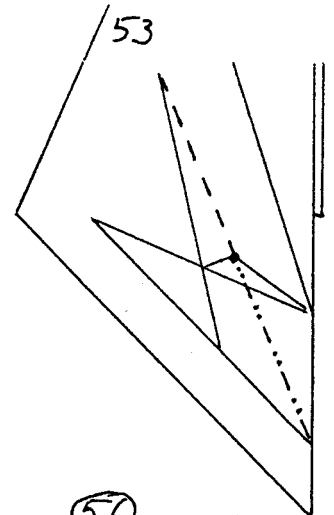
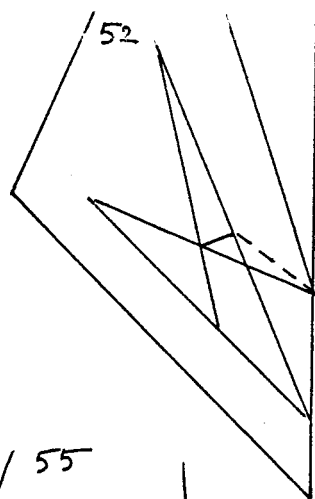
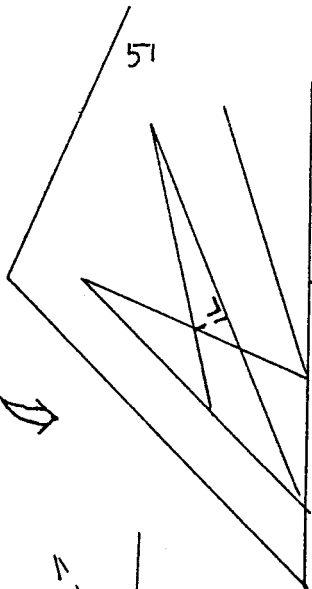
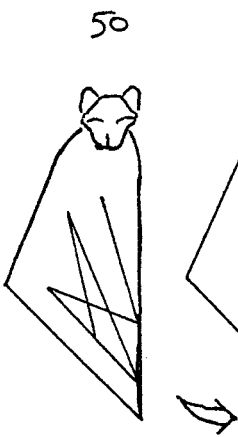
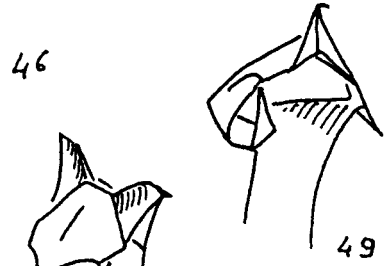
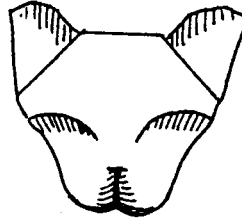
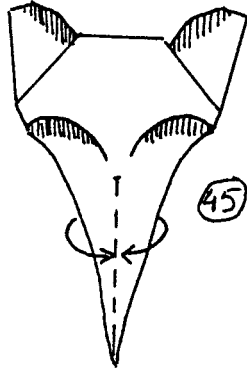
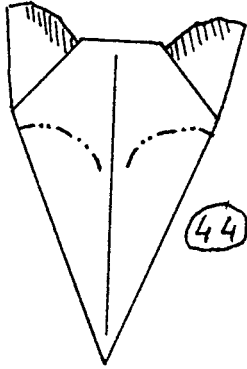
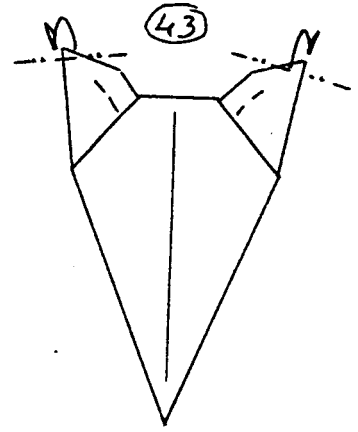
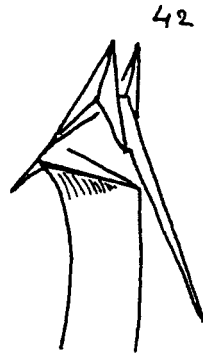
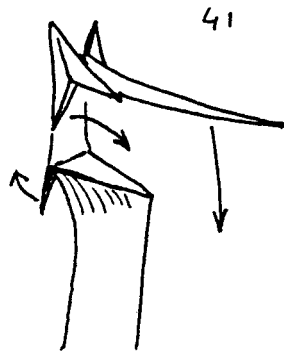
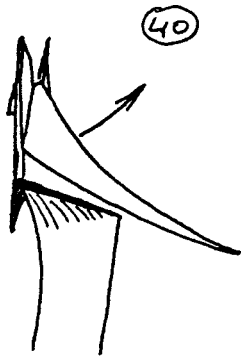

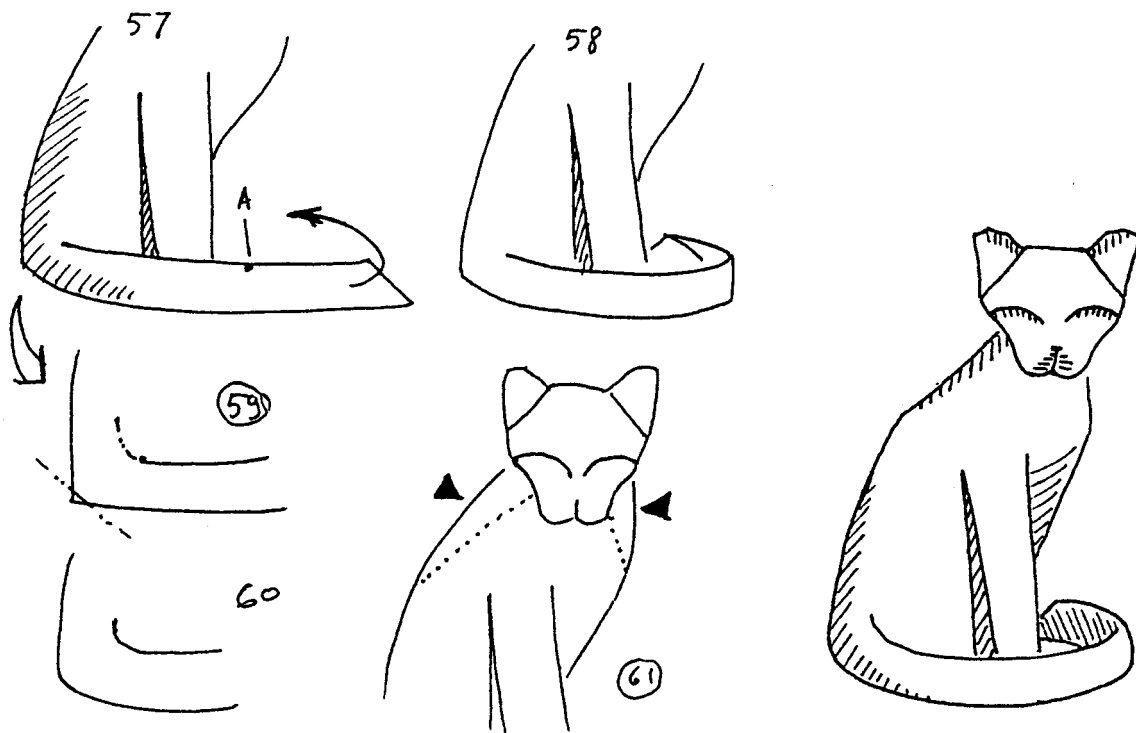

© HERMAN VAN GOUBERGEN 96

A circled number step number on the diagrams means there are written instructions for that step. Please read them before folding. The folding sequence seems very mathematical. In reality most location points are not that critical: It's just a way of minimizing free folding.

6. Fold the bisector. Step 7 indicates the position of the endpoint.
8. Crimp on an existing valleyfold. The mountainfold starts at the endpoint of that valley and Step 9 indicates its angle. Avoid creating the bottom border.
10. Mountain fold starting at A, nearly parallel to Y but widening slightly towards the top. Endpoint C is just a fraction higher than B.
11. Make a tiny mark with your fingernail in the centre of the point.
12. Fold the bisector, starting from the mark in 11. Fold only the bottom third of the point.
16. Fold the point so that its edge crosses the circled point.
19. & 20. Rearrange existing folds on one layer of paper only.
21. Pinch *both* layers of paper at the indicated spots and move your hands together, curving the paper in between (make a bump, not a hollow.) The top point should open out and move down.
24. Twist the top point to the front, wringing the cat's neck.
40. Side view. Pull apart the two layers of the ears.
43. Gently curve the ears, the paper wants to do this anyway.
44. Curved 'eyebrows'. Practice this in a separate sheet first.
45. Inside reverse fold. Don't fold the edges, only curves here.
47. Side view. Get rid of the point by folding it up into the head.
56. Make sure flap A is folded into the tail.
59. Run your thumbnail along the tail furrow and extend it, curving upwards.
61. Gently curve back the paper along the dotted lines.

The final model will need a support to stand.

Copyright © 1996 Herman van Goubergen, all rights reserved.  
 PDF version 1999 by Sebastian Marius Kirsch <skirsch@t-online.de>.  
 Distribution for noncommercial purposes is free. Please contact the author  
 if you want to use this model for commercial purposes.