

Document Lifecycle Tutorial



IETF 77
Anaheim, California
21 March 2010



Overview of This Tutorial

1. Where do RFCs come from?
2. Writing an Internet-Draft
 - Things to think about before writing your draft
 - Contents of an Internet-Draft
3. The lifecycle from Internet-Draft to RFC
4. Common questions and where to find more information



1. Where do RFCs come from?

4 document streams as defined in RFC 4844:

1. IETF

- Working Group
- AD-sponsored (aka Individual)

2. IAB

3. IRTF

4. Independent Submission

RFC Categories



- RFC 2026 defines specification **maturity levels**:
 - Standards track: **Proposed, Draft, Standard**.
 - Non-standards track: **Experimental, Informational, Historic**.
 - "Almost standard": **Best Current Practice**.
- Shown on RFC header as "**Category**:"
 - Except, one category "Standards Track" for PS, DS, S.
 - Often called "status".
- A published RFC can NEVER change, but its *category* can change (see rfc-index.txt).

Streams in Relation to *Categories*

IETF IETF WG to *Standards Track*: Includes WG consensus, review in the IETF, IETF Last Call, and IESG approval

IETF IETF WG to *Experimental/Informational*: Includes WG consensus, review in the IETF, and IESG approval

IETF AD-sponsored to *Standards Track*: Includes review in the IETF, IETF Last Call, and IESG approval

IETF AD-sponsored to *Experimental/Informational*: Includes some form of review in the IETF and IESG approval

IAB / IRTF Documents for which special rules exist

Independent RFC Editor documents to *Experimental/Informational/Historic*

[This list is paraphrased from RFC 3932, recently obsoleted by RFC 5742.]

AD-sponsored (Individual)

Independent

Post as an Internet-Draft.

- Contact the relevant AD.
- Standards Track, Experimental, or Informational category.
- For the process, see <http://www.ietf.org/iesg/statement/ad-sponsoring-docs.html>

- Contact the Independent Submissions Editor (rfc-ise@rfc-editor.org).
- Only Experimental or Informational category.
- ISE reviews and decides whether publication is appropriate.
- Per RFC 5742, IESG reviews for conflict with any WG, makes publish/do-not-publish recommendation.
- ISE has final decision, with advice from Editorial Board.
- See www.rfc-editor.org/indsubs.html and RFC 4846.

RFC Publication Rate

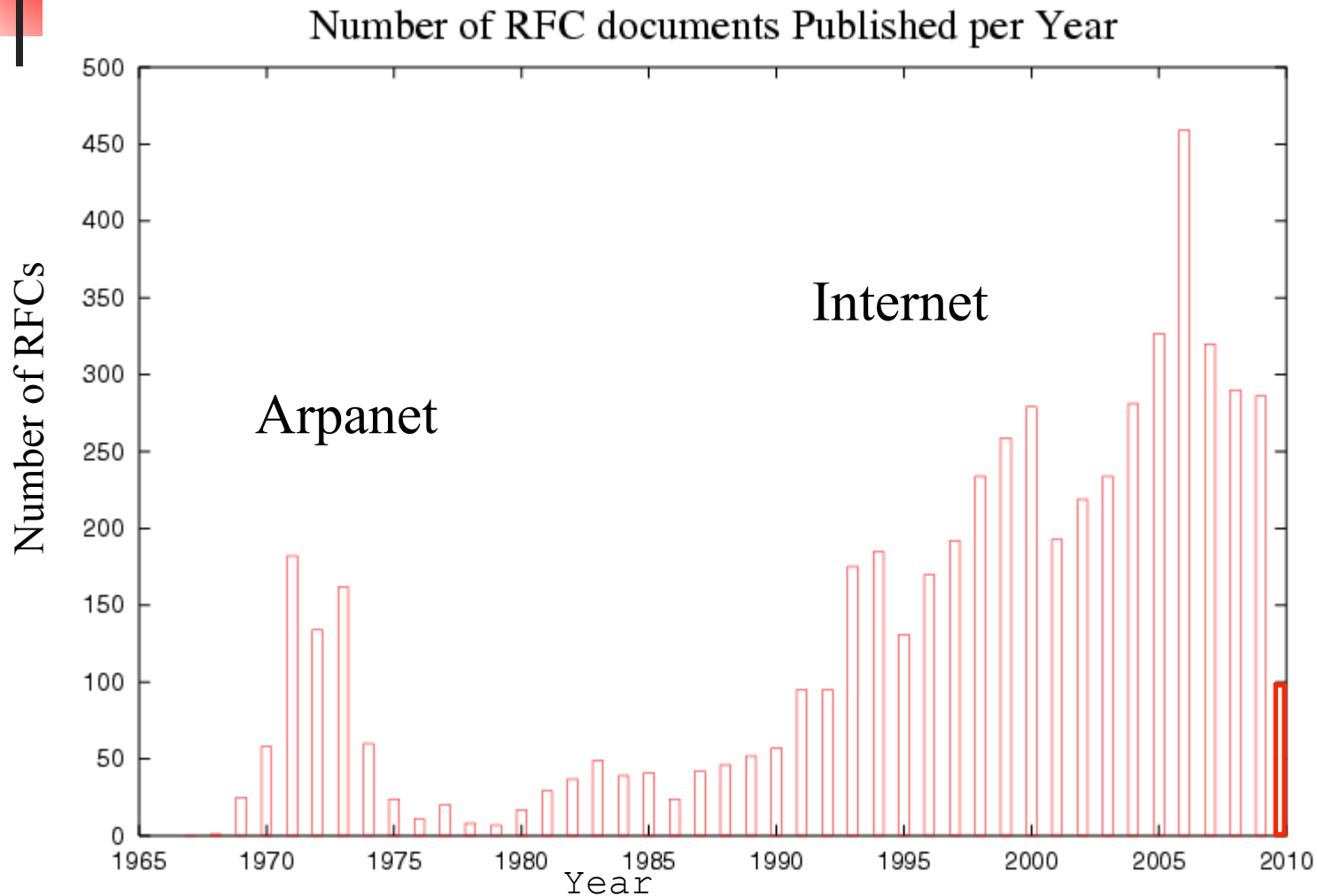

For more information on the RFC Series and its history, see the tutorial slides at www.rfc-editor.org

Implementing the RFC Editor Model (RFC 5620)

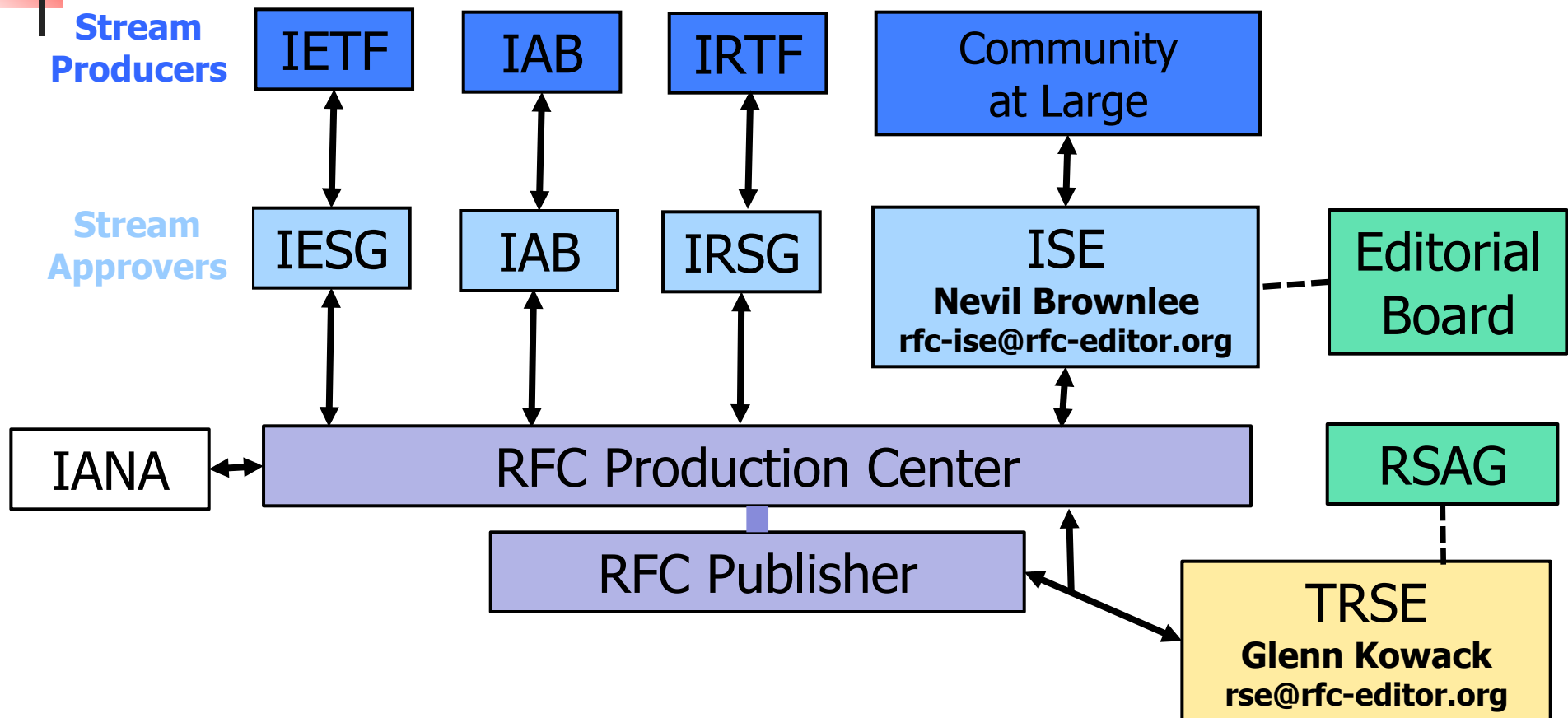

Adapted from RFC 5620, Figure 1: Ordinary RFC Series production and process



Overview of This Tutorial

1. Where do RFCs come from?
2. **Writing an Internet-Draft**
 - Things to think about before writing your draft
 - Contents of an Internet-Draft
3. The lifecycle from Internet-Draft to RFC
4. Common questions and where to find more information

Writing an Internet-Draft

- All RFCs start as an Internet-Draft.
- A well-formed RFC starts with a well-formed I-D.
 - <http://www.ietf.org/ID-Checklist.html> (aka ID-nits)
 - <http://tools.ietf.org/tools/idnits/> (online nits checker)
- Authoring tools
 - <http://www.rfc-editor.org/formatting.html>
 - <http://tools.ietf.org/inventory/author-tools>
 - More on this later.
- Submit using the I-D Submission Tool:
<https://datatracker.ietf.org/idst/upload.cgi>



Overview of This Tutorial

1. Where do RFCs come from?
2. Writing an Internet-Draft
 - Things to think about before writing your draft
 - Contents of an Internet-Draft
3. The lifecycle from Internet-Draft to RFC
4. Common questions and where to find more information



Change Control

- Who should have change control over your document?
 - The IETF has change control over all IETF documents (whether WG or AD-sponsored).
 - You may remain the editor of the document, but it will be your job to reflect IETF consensus
 - If you want to (or need to) retain change control, consider an RFC Editor independent submission
 - Still subject to review, but document does not need to reflect IETF consensus
 - Example: Informational publication of a proprietary protocol -- should be submitted to RFC Editor with name of company in title

Copyrights and Patents



- Copyright issues
 - Specified in [RFC 5378 / BCP 78](#) “Rights Contributors Provide to the IETF Trust” (which obsoletes RFCs 3978 and 4748, and updates RFC 2026). See also <http://trustee.ietf.org/license-info>.
- Patent (“IPR”) issues
 - Specified in [RFC 3979 / BCP 79](#) “Intellectual Property Rights in IETF Technology” (updated by RFC 4879).
- Generally, you supply the correct boilerplate in the Internet-Draft, and the RFC Editor will supply the correct boilerplate in the RFC.



Patents and IETF Documents

- Will the IETF publish standards that include patented technology?
 - Yes, but WGs may prefer non-patented technology
 - Licensing terms may affect WG acceptance and what implementations are available
- If you know of patented technology in your draft
 - Declare it immediately after publication
 - Carefully consider your patent terms

Text Formatting Tools



- Author tools: www.rfc-editor.org/formatting.html
 - xml2rfc
 - nroff
 - Microsoft word template (see RFC 5385)
 - LaTeX
- RFC Editor does final RFC formatting using venerable Unix tool nroff -ms.
- See also: <http://tools.ietf.org/inventory/author-tools>

xml2rfc (<http://xml.resource.org>)

- The xml2rfc tool converts an XML source file to text, HTML, or nroff. RFC 2629 and its unofficial successor define the format.
- xml2rfc FAQ:
<http://xml.resource.org/xml2rfcFAQ.html>
- XML templates are available from
<http://tools.ietf.org/tools/templates>:
 1. For a generic I-D (e.g., draft-davies-template-bare.xml)
 2. For an I-D containing a MIB (e.g., mib-doc-template-xml.txt)



Overview of This Tutorial

1. Where do RFCs come from?
2. Writing an Internet-Draft
 - Things to think about before writing your draft
 - Contents of an Internet-Draft
3. The lifecycle from Internet-Draft to RFC
4. Common questions and where to find more information



4. Contents of an Internet-Draft

- Header
- Title
- Abstract
- Status of This Memo [boilerplate]
- Copyright Notice [See RFC 5378 and <http://trustee.ietf.org/license-info>]
- Table of Contents [not required for short docs]

- Body
 - IANA Considerations (RFC 5226)
 - Security Considerations (RFC 3552)
 - Internationalization Considerations (RFC 2277)

- Authors' Addresses

Internet-Draft Header

IETF PKIX WG

Internet Draft

Intended Status: Standards Track

Obsoletes: 3281 (once approved)

Expires: October 27, 2009

S. Farrell, Trinity College Dublin

R. Housley, Vigil Security

S. Turner, IECA

April 27, 2009

**An Internet Attribute Certificate Profile for Authorization
draft-ietf-pkix-3281update-05.txt**

Helpful:

- Intended Status (Category)
- Updates, Obsoletes: relation to earlier RFCs (if any)

RFC Header (as recently updated by RFC 5741)

Internet Engineering Task Force (IETF)
Request for Comments: 5755
Obsoletes: 3281
Category: Standards Track
ISSN: 2070-1721

S. Farrell
Trinity College Dublin
R. Housley
Vigil Security
S. Turner
IECA
January 2010

Corresponding RFC search result:

Number	Title	Author or Ed.	Date	Format	More Info (Obs&Upd)	Status
RFC5755	An Internet Attribute Certificate Profile for Authorization	S. Farrell, R. Housley, S. Turner	January 2010	ASCII	Obsoletes RFC3281	PROPOSED STANDARD

Here is post-publication metadata: Obsoleted by, Updated by, or Errata
Also found in metadata pages (www.rfc-editor.org/info/rfcXXXX) and tools.ietf.org HTML versions.

Authors in Header



- Limited to lead authors, document editors.
- There must be very good reason to list more than 5.
- Each author in the header must give approval during AUTH48 review.
- Each author in the header should provide unambiguous contact information in the Authors' Addresses section.
- Other names can be included in Contributors and/or Acknowledgments sections.

Titles



- Should be thoughtfully chosen
- No un-expanded abbreviations - except for very well-known ones (e.g., IP, TCP, HTTP, MIME, MPLS)
 - List available from <http://www.rfc-editor.org/styleguide.html>
- We like short, snappy titles, but sometimes we get titles like:
 - *"An alternative to XML Configuration Access Protocol (XCAP) for manipulating resource lists and authorization lists, Using HTTP extensions for Distributed Authoring and Versioning (DAV)"*

Abstracts

- Carefully written for clarity (*HARD* to write!)
- No un-expanded abbreviations (again, except well-known)
- No citations
 - Use “RFC xxxx”, not “[RFCxxxx]” or “[5]”
- Less than 20 lines! Shorter is good.
- **Not a substitute for the Introduction;** redundancy is OK.
- We recommend starting with “This document...”



Body of an Internet-Draft

- First section should generally be “1. Introduction”.
- Special sections that may appear:
 - Contributors, Acknowledgments
 - Internationalization Considerations
 - When needed -- see Section 6, RFC 2277/BCP 18.
- Sections that **MUST** appear:
 - IANA Considerations
 - Security Considerations
 - References (Normative and/or Informative)

IANA Considerations Section



- What is an IANA Considerations section?
 - A guide to IANA on what actions will need to be performed
 - A confirmation if there are NO IANA actions
- Section is required in draft
 - But “No IANA Considerations” section will be removed by RFC Editor.



Why is this section important?

- Forces the authors to 'think' if anything should be requested from IANA
- A clear IANA Considerations section will allow the IANA to process the IANA Actions more quickly
- Establishes documented procedures

What should be included in the IANA Considerations section?

- What actions is the document requesting of IANA
- Individual number or name registrations
- New registries (number or name spaces)
- Registration procedures for new registries
- Reference changes to existing registrations

BE CLEAR AND DESCRIPTIVE IN YOUR INSTRUCTIONS
(IANA is not the expert for your name or number space)



Review of IANA Considerations

- IANA Consideration sections are reviewed before the document is published as an RFC
 - During IETF Last Call
 - During IESG Evaluation
 - IANA will also review your section at any time by request
- If you do not have an IC section or if your IC section is not complete, your document will not move forward



Where to get help on writing this section

- See RFC 5226, “Guidelines for Writing an IANA Considerations Section in RFCs”
- Look at existing registries for examples
- Ask IANA
 - Available at the IANA booth at IETF meetings
 - Send an e-mail [iana@iana.org] or [michelle.cotton@icann.org]



Security Considerations Section

- Security Considerations section **required** in every RFC.
- See [RFC 3552](#): “Guidelines for Writing RFC Text on Security Considerations”
- Important!

References



- Normative vs. Informative
 - Normative refs can hold up publication.
- Citations and references must match.
- Handy files of RFC reference entries:
 - <ftp://ftp.rfc-editor.org/in-notes/rfc-ref.txt>
 - For xml2rfc: <http://xml.resource.org/public/rfc/bibxml/>
- Include draft strings of any I-Ds.



Writing the body of your draft

- Editorial guidelines
- Formal languages and MIBs

Primary Sources:

1. Internet-Draft Guidelines:

<http://www.ietf.org/id-info/guidelines.html>

2. RFC Style Guide:

<http://www.rfc-editor.org/styleguide.html>



Writing Internet-Drafts

- Primary goal: **clear, unambiguous technical prose.**
- Think about internally consistent usage:
 - Use the same terminology and notation throughout.
 - If you choose “4-bit”, don’t switch to “four-bit”.
 - Expand each abbreviation at first use.
 - See the abbreviations and terms lists available from <http://www.rfc-editor.org/styleguide.html>



Grammar Tips

- Avoid passive voice (backwards sentences).
 - “In this section, the network interface is described.”
vs. “This section describes the network interface.”
- Some Protocol Engineers over-capitalize Nouns.
- “which” vs. “that”
For example:
 - (non-restrictive which: all RST attacks rely on brute-force)
 - **It should be noted that RST attacks, which rely on brute-force, are relatively easy to detect at the TCP layer.**
 - (restrictive that: only *some* RST attacks rely on brute-force)
 - **It should be noted that RST attacks that rely on brute-force are relatively easy to detect at the TCP layer.**



Punctuation Conventions

- A comma before the last item of a series:
 - “TCP service is reliable, ordered, and full-duplex”
 - Avoids ambiguities, clearly shows parallelism.
- Punctuation outside quote marks:
“This is a sentence”{.|?|!}
 - To avoid computer language ambiguities.

Use of Formal Languages



- Formal languages and pseudo-code can be useful as an aid in explanations, although English remains the primary method of describing protocols.
- Pseudo-code judged on the basis of clarity. See IESG's guidance: <http://www.ietf.org/IESG/STATEMENTS/pseudo-code-in-specs.txt>
- Formal Languages (e.g., ABNF, XML, MIBs)
 - Requires a normative reference to language specification
 - RFC Editor will run verifier
 - See list of verification tools: <http://tools.ietf.org/inventory/verif-tools>

MIB RFCs: A Special Case



- MIB references
 - O&M Web Site at www.ops.ietf.org/
 - MIB doctors at www.ops.ietf.org/mib-doctors.html
 - MIB Review: See RFC 4181, BCP 111: "Guidelines for Authors and Reviewers of MIB Documents"
- Tools
 - <http://www.ops.ietf.org/mib-review-tools.html>
 - smilint at www.ibr.cs.tu-bs.de/projects/libsmi/
 - SMICng at www.snmpinfo.com/
- MIB boilerplate
 - The Internet-Standard Management Framework:
www.ops.ietf.org/mib-boilerplate.html
 - Security Considerations: www.ops.ietf.org/mib-security.html



Hints to Authors

- Read your I-D carefully **before** submission, as you would read the final document in AUTH48!
- If your I-D is in the queue, and you see typos or have a new email address, send us an email.
- Craft title, abstract, and introduction carefully.
- Avoid gratuitous use of RFC 2119 requirement words (MUST, etc.)
- Don't use numeric citations (unless you submit an XML file).
- Remember that your document should be understandable by people who are not deep experts in the subject matter.



Overview of This Tutorial

1. Where do RFCs come from?
2. Writing an Internet-Draft
 - Things to think about before writing your draft
 - Contents of an Internet-Draft
3. The lifecycle from Internet-Draft to RFC
4. Common questions and where to find more information

IETF Document Lifecycle

WG documents go through the WG process...

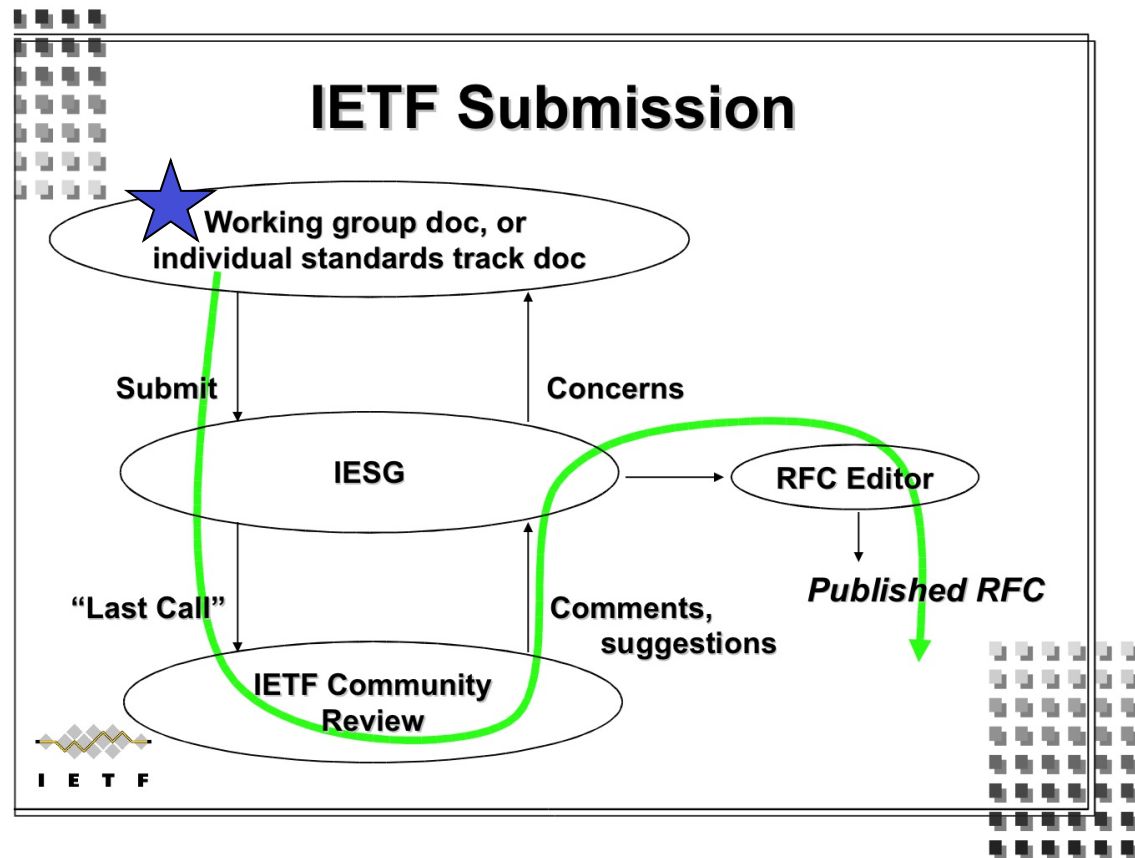

Diagram taken from Scott Bradner's Newcomer's Tutorial



Steps in the WG process

- Initial Submission
- Author Refinement
- WG Acceptance
- Editor Selection
- WG Refinement
- WG Last Call
- WG Request to Publish



Steps in the WG process

- Initial Submission
 - Original idea or issue is submitted to the WG
 - May be done via mailing list or at a meeting
 - Should become an Internet-Draft (or part of one)
 - Chairs will reject submissions that don't fit within the WG charter, in chair judgment
 - May refer submission to more appropriate groups or areas
 - Chairs should reject submissions that aren't relevant or don't meet minimal quality requirements
 - There is no admission control on IETF Internet-Drafts
 - Rejections can be appealed



Steps in the WG process

- Author Refinement

- Idea is more fully documented or refined based on feedback
 - May be done by the person who originally submitted the idea/issue, or by others
 - May be done by individual, ad hoc group or more formal design team
- Change control lies with author(s) during this phase



Steps in the WG process

- WG Acceptance
 - For a document to become a WG work item, it must:
 - Fit within the WG charter (in the opinion of the chairs)
 - Have significant support from the working group, including:
 - People with expertise in all applicable areas who are willing to invest time to review the document, provide feedback, etc.
 - Current or probable implementers, if applicable
 - Be accepted as a work item by a rough consensus of the WG
 - Should reflect WG belief that the document is taking the correct approach and would be a good starting place for a WG product
 - Have corresponding goals/milestones in the charter
 - Goals/milestones approved by the Area Directors
 - Adopting a specific draft is not approved by Area Directors



Steps in the WG process

- Editor Selection

- Editor(s) will be selected by the WG chairs
 - Usually one or more of the original authors – but not always
 - Must be willing to set aside personal technical agendas and change the document based solely on WG consensus
 - Must have the time and interest to drive the work to completion in a timely manner
- Make this decision explicitly, not by default!
 - Some people are concept people, some are detail people
 - Some people start strong, some people finish strong
 - Some people have changes in life circumstances



Steps in the WG process

- WG Refinement

- Document updated based on WG consensus
 - All technical issues and proposed changes MUST be openly discussed on the list and/or in meetings
 - All changes must be proposed to the mailing list
 - Complex changes should be proposed in separate IDs
 - The WG has change control during this phase
 - Changes are only made based on WG consensus
 - During this phase, silence will often indicate consent



Steps in the WG process

- WG Last Call
 - Generally the final check that the WG has rough consensus to advance the document to the IESG
 - The WG believes that this document is technically sound
 - The WG believes that this document is useful
 - The WG believes that this document is ready to go to the IESG
 - A disturbingly large number of people wait until WGLC to read drafts!



Steps in the WG process

- WG Last Call

- The document must be reviewed and actively supported by a significant number of people, including experts in all applicable areas
 - ... or it should not be sent to the IESG
- Silence does NOT indicate consent during this phase
- Why would we want to waste IESG time on a document that we can't be bothered to review ourselves?



Has anyone else read the draft?

- Standards-track documents reflect IETF views
 - Not just a working group's view
- Standards-track protocols run on the Internet
- Avoid the group-think trap
 - Ask "who else should be reading this draft?"
 - Your ADs are good sources of potential reviewers
- Don't wait until the last minute to share
 - Prevent the "last-minute surprise"
- Some "last-minute surprise" examples
 - Discovering that no one plans to implement the new spec
 - Discovering that the security mechanism does not meet current requirements
 - Learning that work overlaps or conflicts with work in other WGs

IETF Document Lifecycle

When ready, documents are submitted to the IESG for approval...

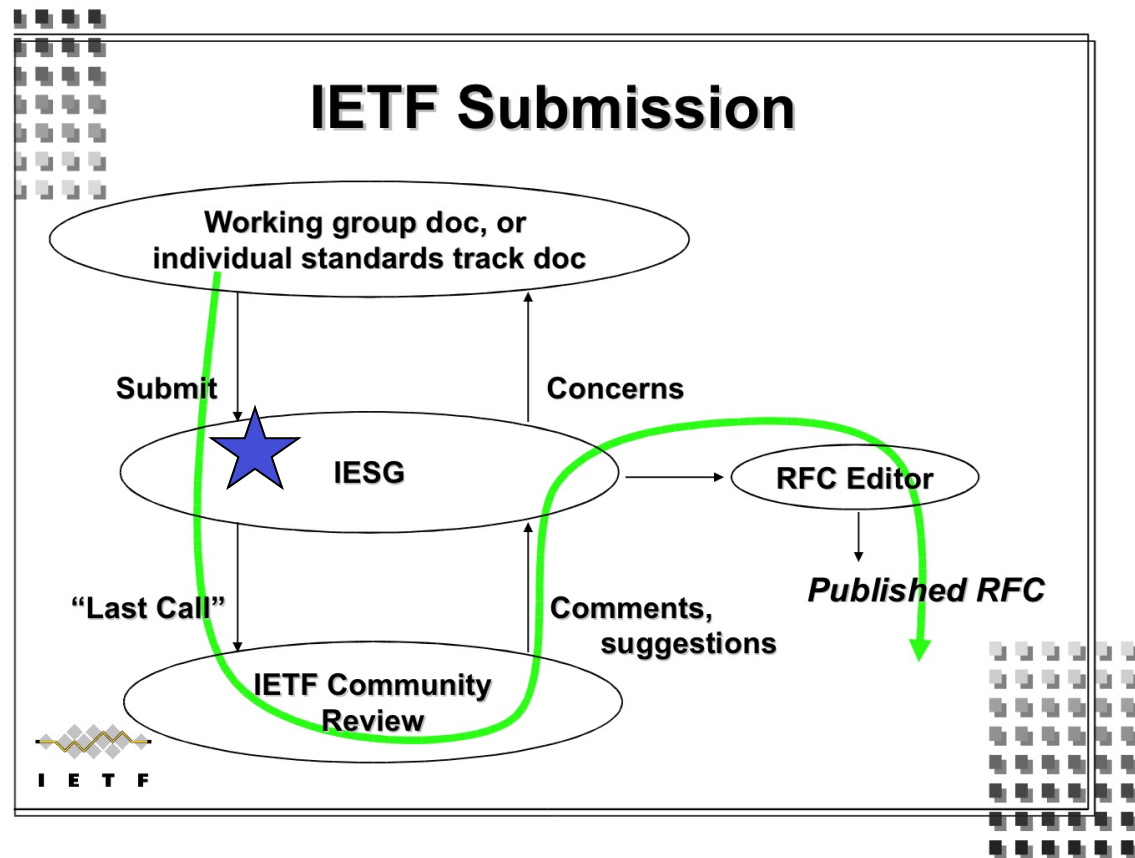

Diagram taken from Scott Bradner's Newcomer's Tutorial



Document Shepherding

- Must be one Shepherd for every draft to be published
 - Usually a WG chair for a WG document
- Provide the PROTO write up as the request to your AD for publication
 - RFC 4858: Document Shepherding from Working Group Last Call to Publication
- During AD evaluation, manage discussion between editors, WG, and AD
- During IETF Last Call, follow up on feedback and comments
- During IETF Last Call, follow up on all IESG feedback
- Follow up on all IANA and RFC Editor requests



IESG review, early steps

- Document shepherd sends a Publication Request to the IESG, including a PROTO write-up
- After Publication Request, status of the document can be found in the Internet-Draft Tracker
 - <https://datatracker.ietf.org/doc/>
- Before moving to next steps, your AD must approve the document
 - May include review by area directorate(s) or other experts
 - Sometimes the AD asks for a revision to clear his/her own objections before advancing

IETF Document Lifecycle

AD sends standards track or individual documents for full IETF Review...

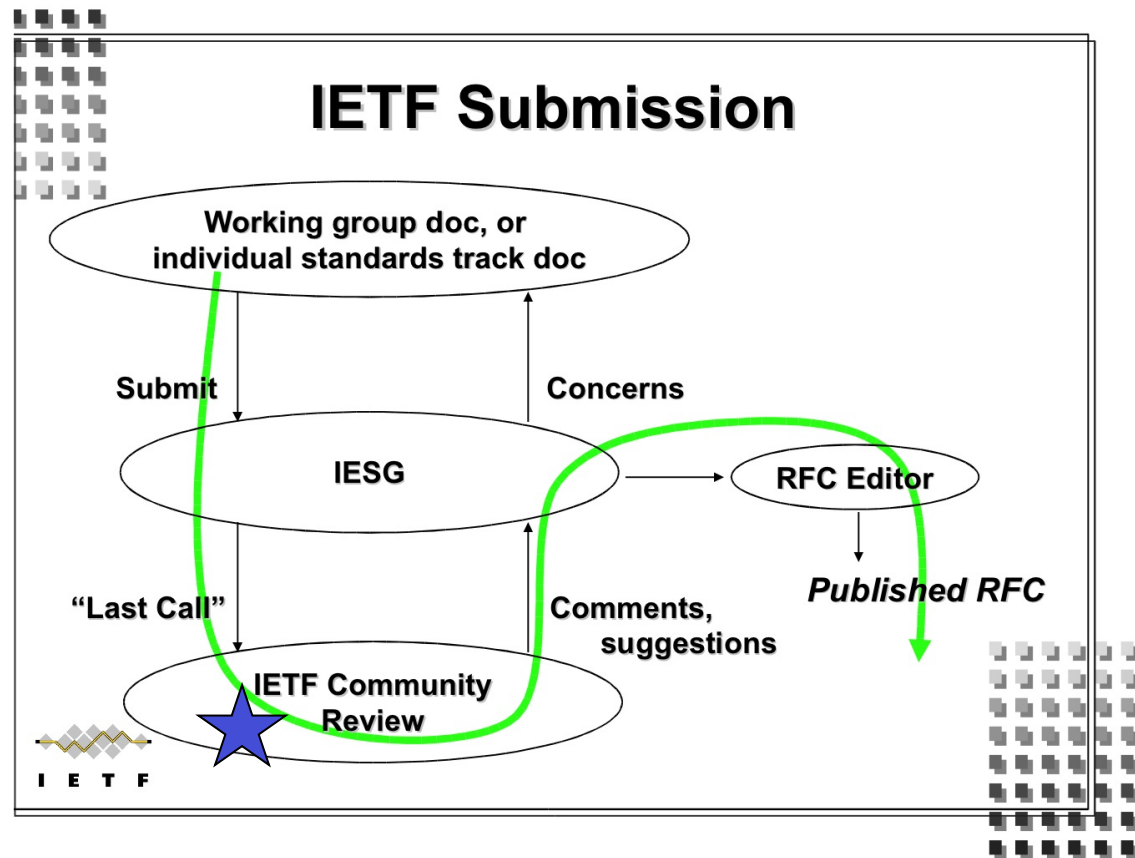

Diagram taken from Scott Bradner's Newcomer's Tutorial



IETF Last Call

- After the AD approves the document, he/she may send the document for a final IETF review called “IETF Last Call” (IETF LC)
- Length of the IETF LC depends on document type and history
 - All Standards Track and BCP documents go to IETF LC
 - AD-sponsored individual submissions have a 4-week IETF LC
 - WG documents have a 2-week IETF LC
 - AD may choose to send informational or experimental documents for an IETF LC
 - Key architecture or framework documents
- During IETF LC, individuals, cross-area review teams and directorates will review the document
 - All comments must be addressed before the document advances

IETF Document Lifecycle

Document is reviewed and approved by the full IESG...

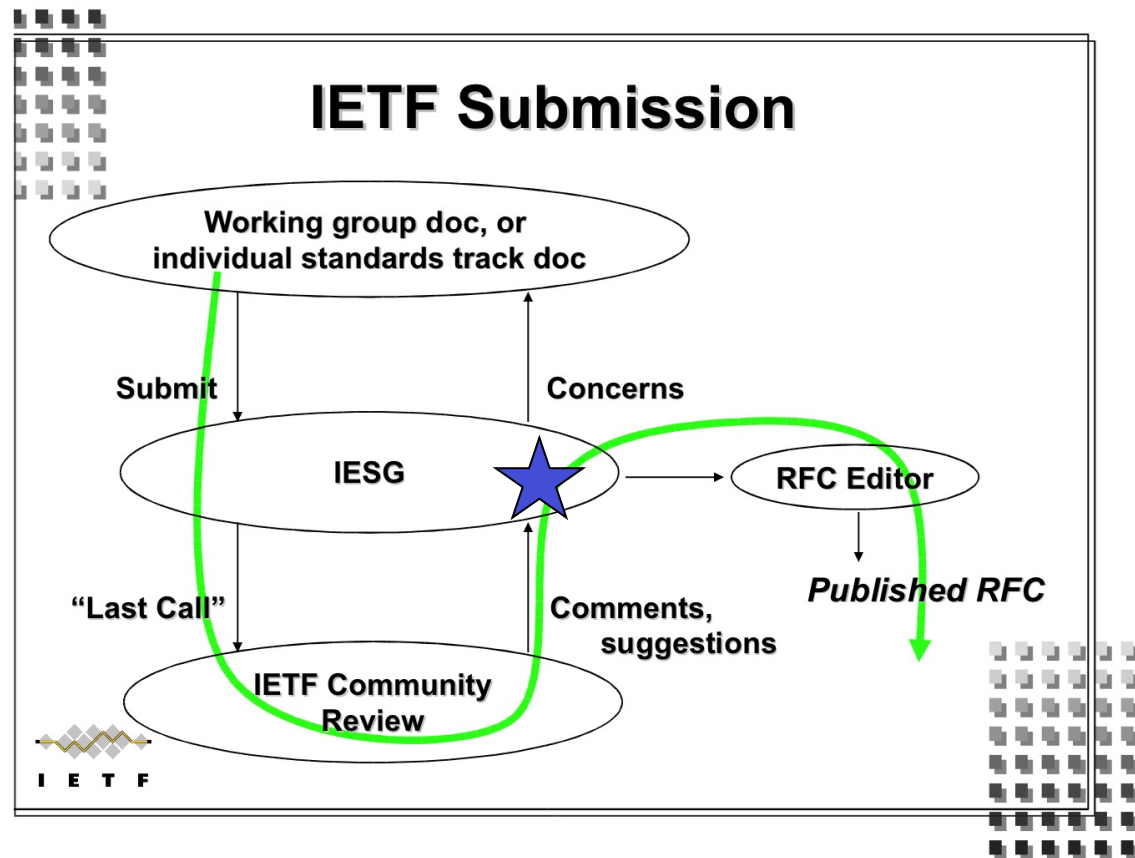

Diagram taken from Scott Bradner's Newcomer's Tutorial



IESG review, later steps

- Directorate Reviews
 - Many ADs/Areas have directorates that they use to review documents before approval
 - MIB Doctors, Security Directorate, Gen ART, etc.
 - If these reviews were not completed during IETF LC, they may be done now
- Official IANA Review
 - Looks at IANA Considerations to figure out the namespaces that will need to be IANA managed and/or additional entries in existing namespaces



IESG cross-discipline review

- Takes IETF Last Call comments into account
- Can decide to pass document on for publication
- Makes final decision on document track/status
- Can send document back to WG with comments and “DISCUSS” issues that must be resolved before the document proceeds to RFC
 - <http://www.ietf.org/u/ietfchair/discuss-criteria.html>
- If you negotiate significant changes with the IESG, please show them to your WG before RFC publication!

IETF Document Lifecycle

After your document has been approved by the IESG...

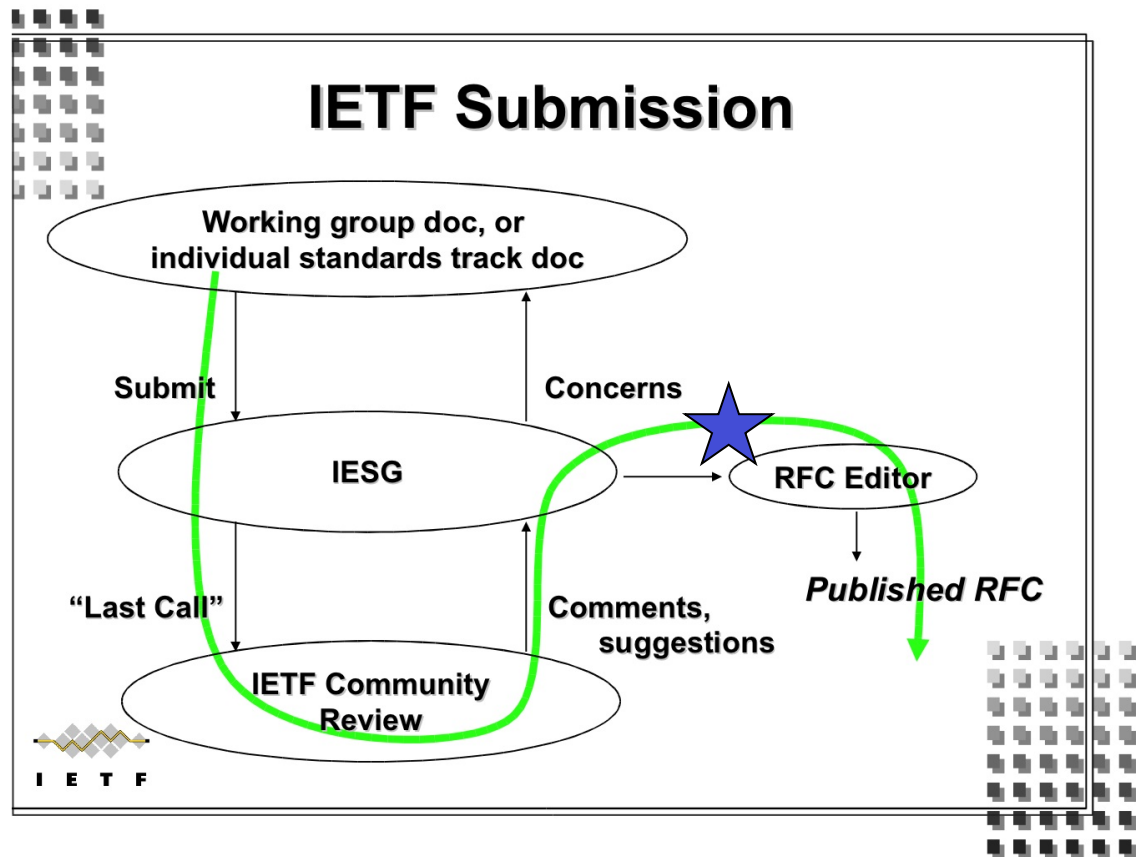



RFC Editor Publication Process

- IESG approval -> your document is added to the queue
- Step 1: Send your source file.
 - questions from the RFC Editor
- Step 2: Answer questions.
 - AUTH48 notification with a pointer to the edited version
- Step 3: Review your document carefully and send changes / approvals for publication.
- Step 4: See your document progress.
- Step 5: Publication!

Step 1: Send your source file.



From: rfc-editor@rfc-editor.org

Subject: [RFC State] <draft-ietf-wg-topic-05> has been added to RFC Editor database.

- Your document has been added to the queue (www.rfc-editor.org/queue2.html).
- Please send us your nroff or xml source file.
 - Let us know if there are any changes between the version you send and the IESG-approved version.
- If you don't have one, don't worry, we will use the Internet-Draft text to create an nroff file.

Step 2: Answer questions.



From: rfc-editor@rfc-editor.org or *@ams1.com
Subject: draft-ietf-wg-topic-05

- Please reply to questions about your draft. Typically, these questions are about
 - missing citations
 - Ex: [RFC4301] appears as a normative reference, where would you like to cite it in the text?
 - inconsistent terminology
 - Ex: Which form of the term should be used throughout?
RESTART Flag / Re-Start flag / Restart Flag
 - unclear sentences

Step 3: See your document progress.



From: rfc-editor@rfc-editor.org

Subject: [RFC State] <draft-ietf-wg-topic-05> has changed state

Basic Process

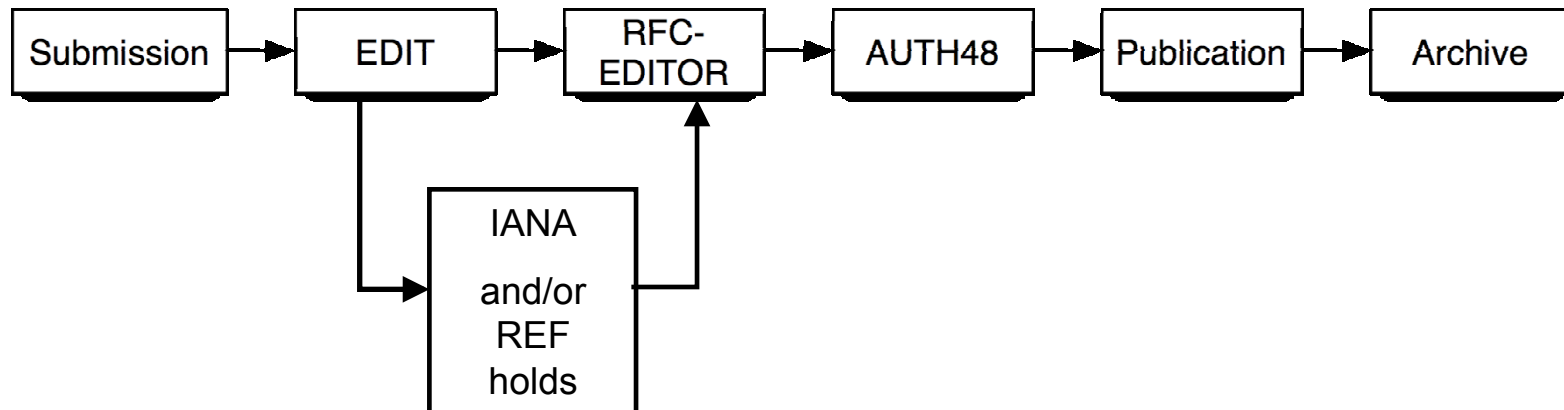

Also, you can check <http://www.rfc-editor.org/queue2.html>



More details on queue states

- Normative References
 - Set of RFCs linked by normative refs must be published simultaneously : Shown as “clusters”.
 - Two hold points:
 - MISSREF state: a doc with norm. ref to a doc not yet received by RFC Editor.
 - REF state: a doc that is edited but waiting for dependent docs to be edited.

- IANA
 - Acts on IANA Considerations section (as discussed earlier).
 - Creates new registries and assigns numbers.

Step 4: Review your document carefully.



From: rfc-editor@rfc-editor.org

Subject: AUTH48 [SG]: RFC 4999 <draft-ietf-wg-topic-05>

- This is your chance to review the edited version.
- We send pointers to the txt and diff files
 - and the XML file (when AUTH48 in XML)
- Submit changes by sending OLD/NEW text or indicating global changes.
 - Insert directly into the XML file (when AUTH48 in XML)
- Each author listed on the first page must send their approval before the document is published.



More about AUTH48: Final Author Review

- Last-minute editorial changes allowed, but should not be substantive or too extensive.
 - Else, we request approval from the Area Director.
- This process can involve a fair amount of work & time
 - AT LEAST 48 hours!
 - Each listed author approves the document before publication. Approvals are tracked on AUTH48 page (link from the queue page).
 - Authors should take it seriously - review the entire document, not just the diffs.
 - Your last chance to avoid enrollment in the *Errata Hall of Infamy!*

IETF Document Lifecycle

Congratulations!
Your document
is now an RFC...

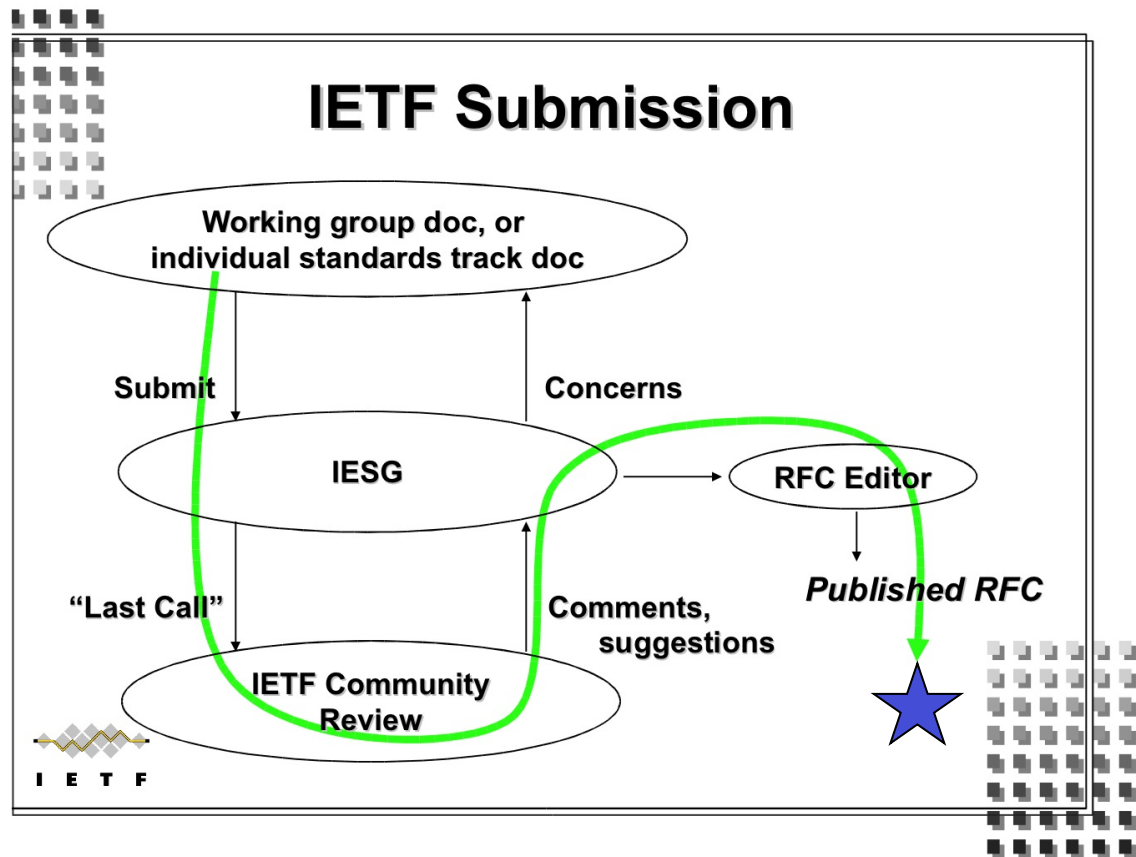



Step 5: Publication!

- Announcement sent to lists:
ietf-announce@ietf.org and rfc-dist@rfc-editor.org
- Canonical URI:
<http://www.rfc-editor.org/rfc/rfcXXXX.txt>
- Also available here:
<ftp://ftp.rfc-editor.org/in-notes/rfcXXXX.txt>
- Mirrored at IETF site and other sites.
- NROFF and XML source files archived for later revisions.



Errors in RFCs

www.rfc-editor.org/errata.php

- A list of technical and editorial errors that have been reported to the RFC Editor.
- Errata status indicates whether it is Reported (not yet reviewed), Verified, or Rejected. New status is “Hold for Document Update”.
- The RFC Editor search engine results contain hyperlinks to errata, when present.
- How to report errata
 - Use the online form available from the errata page.



Overview of This Tutorial

1. Where do RFCs come from?
2. Writing an Internet-Draft
 - Things to think about before writing your draft
 - Contents of an Internet-Draft
3. The lifecycle from Internet-Draft to RFC
4. Common questions and where to find more information



Q: Why hasn't my draft been published as an RFC?

A: You can check the state of your document on www.rfc-editor.org/queue2.html

- "IANA" indicates waiting on IANA considerations
- "REF" indicates there are normative references. These lead to clusters of documents: click the cluster number on the queue page to see details.
- "[AUTH48](#)" indicates each author must send final approval of the document. Follow the link for the detailed status.



Q: What if one of the authors cannot be located during AUTH48?

A: You have several options:

- An AD can approve the document in place of the unavailable author. See <http://www.ietf.org/iesg/statement/auth48.html>
- The author can be moved to a Contributors or Acknowledgments section.

Q: What about April 1st RFCs?

- April 1st RFCs: Jon Postel's playful side
 - A little humorous self-parody is a good thing...
 - Most, but not all, April 1st RFCs are satirical documents.
 - We expect you can tell the difference ;-)
- April 1 submissions are reviewed for cleverness, humor, and topical relation to IETF themes.
 - Avian Carriers is famous (RFC 1149)
 - Evil Bit is a favorite (RFC 3514)
- Send submissions to the RFC Editor.



The IETF Web Site & IETF Tools

<http://www.ietf.org>

- Working Group charters, mailing lists
- Meeting agendas and proceedings
- I-D Submission and I-D Tracker
- IESG actions

<http://tools.ietf.org>

- Tools for preparing drafts, viewing drafts, communicating, following IETF meetings



The RFC Editor Web Site

<http://www.rfc-editor.org>

- Search engines for RFCs, Internet-Drafts
- RFC publication queue
- Master index of RFCs
 - <ftp://ftp.rfc-editor.org/in-notes/rfc-index.txt>, .xml
- “Official Internet Protocols Standards” list
- Policy changes, news, FAQ, and more
- Errata look-up and reporting



Thank you

- Questions? Comments?
- Ask us now!
- IETF 77: Stop by the RFC Editor or IANA Desks.
- RFC Editor Interest List: rfc-interest@rfc-editor.org
- Contact us later:
 - Alice Hagens, RFC Editor, rfc-editor@rfc-editor.org
 - Margaret Wasserman, mrw@lilacglade.org